

### 车身底部保护涂层

为了防锈、防碎石爆边和防震，在底板和车轮罩底部应用了车身底部保护涂层。因此，更换或维修这些板件时，在这些部件上应用车身底部保护涂层。

禁止车身底部防锈剂接触轮胎、消音器和排气管。

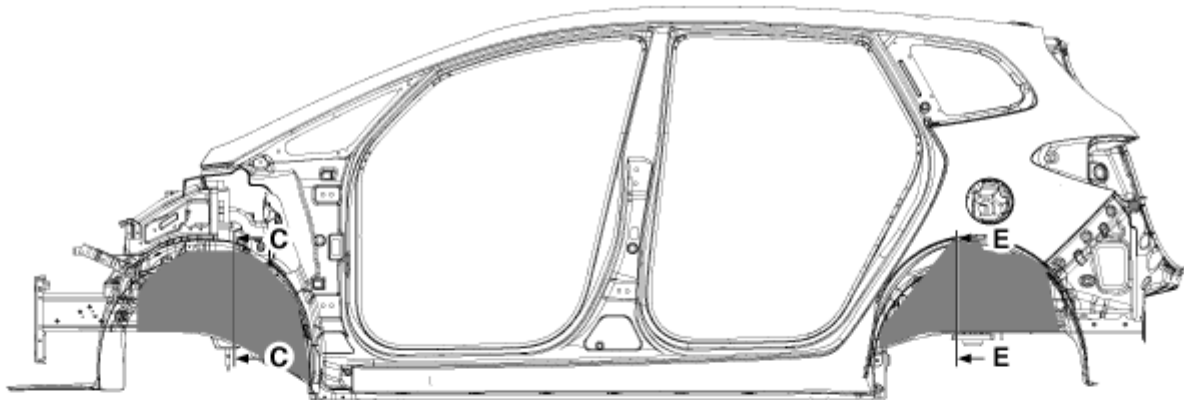

侧视图

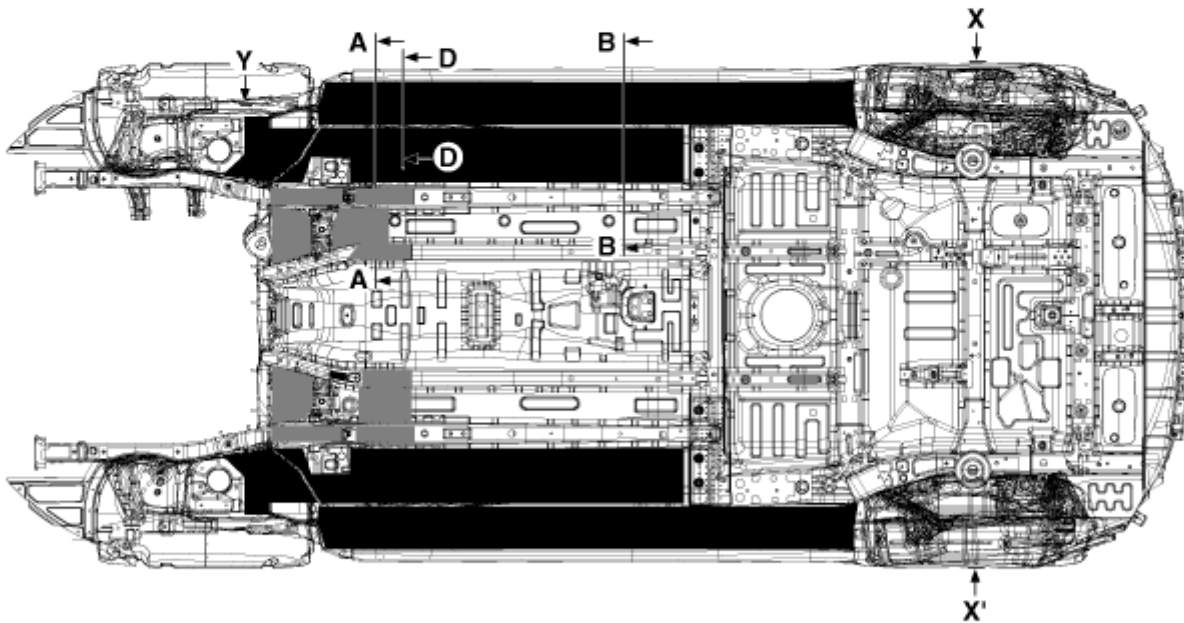

底视图

车身底部涂层 (厚度 : 0.8 mm , : 1.0 mm)

A - A

B - B

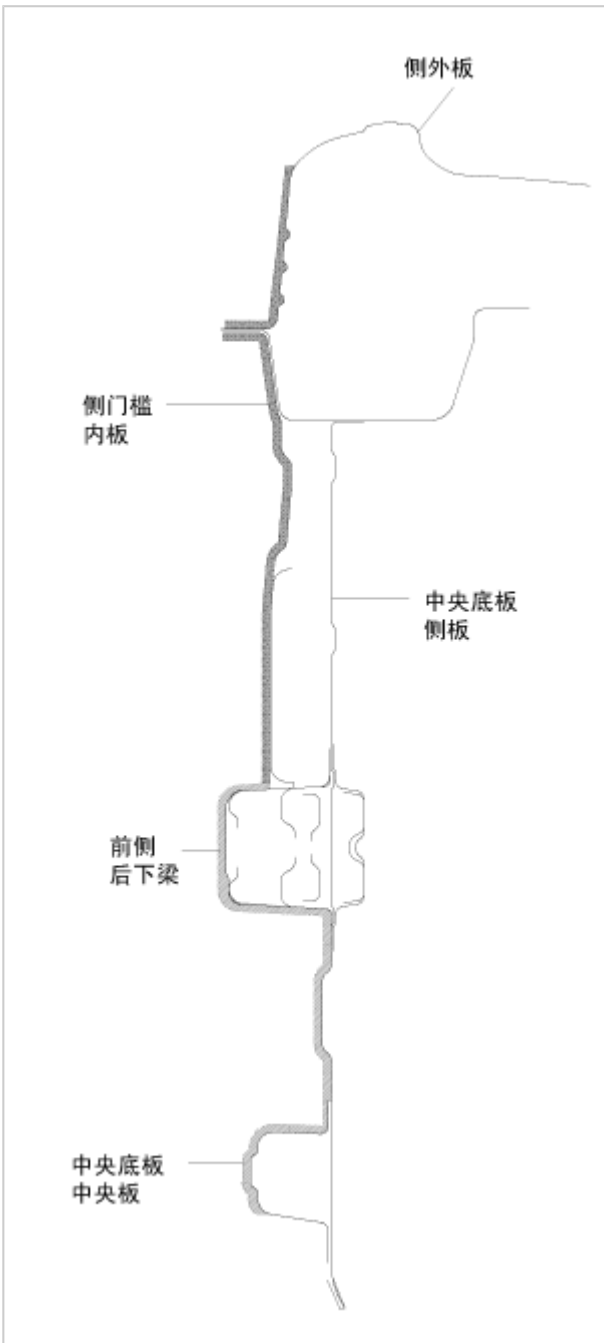

C - C

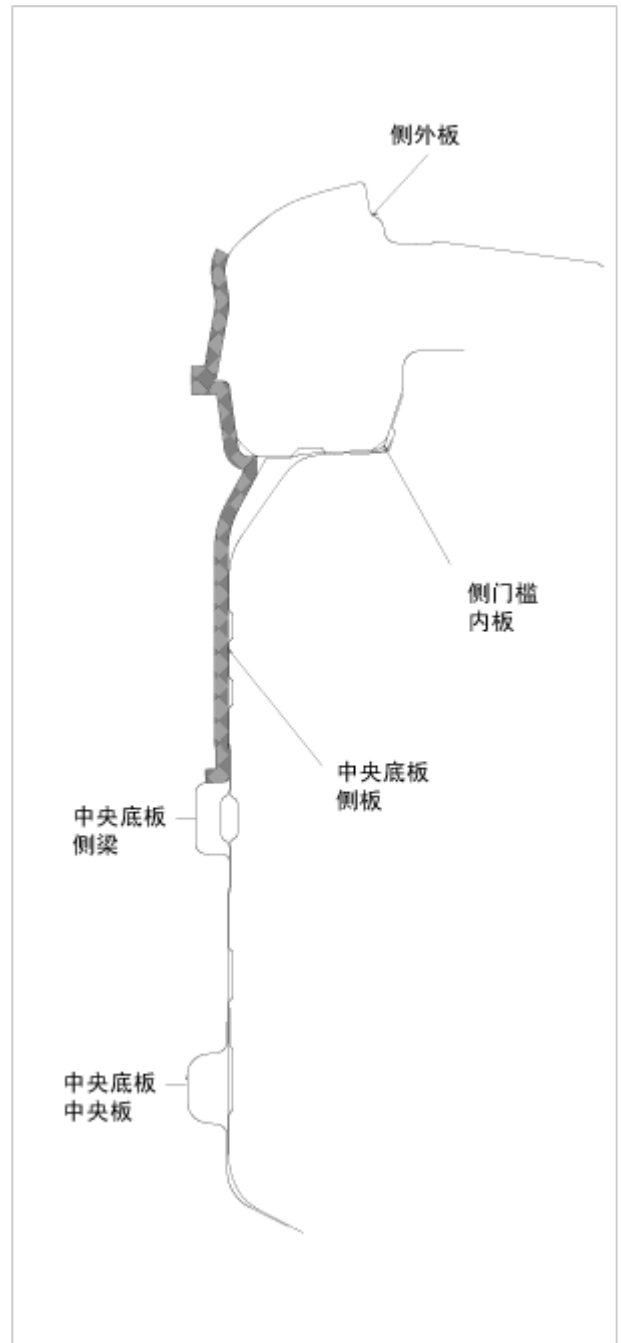

D-D

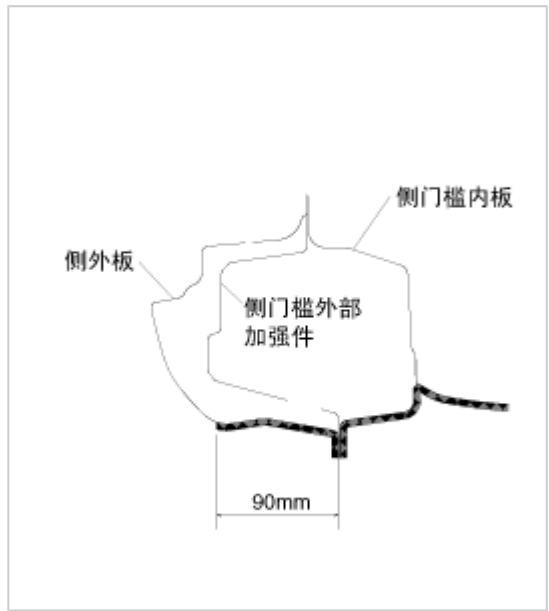
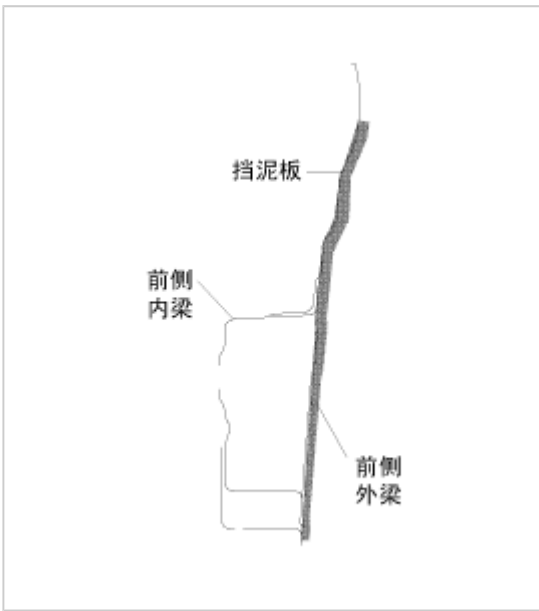

E-E

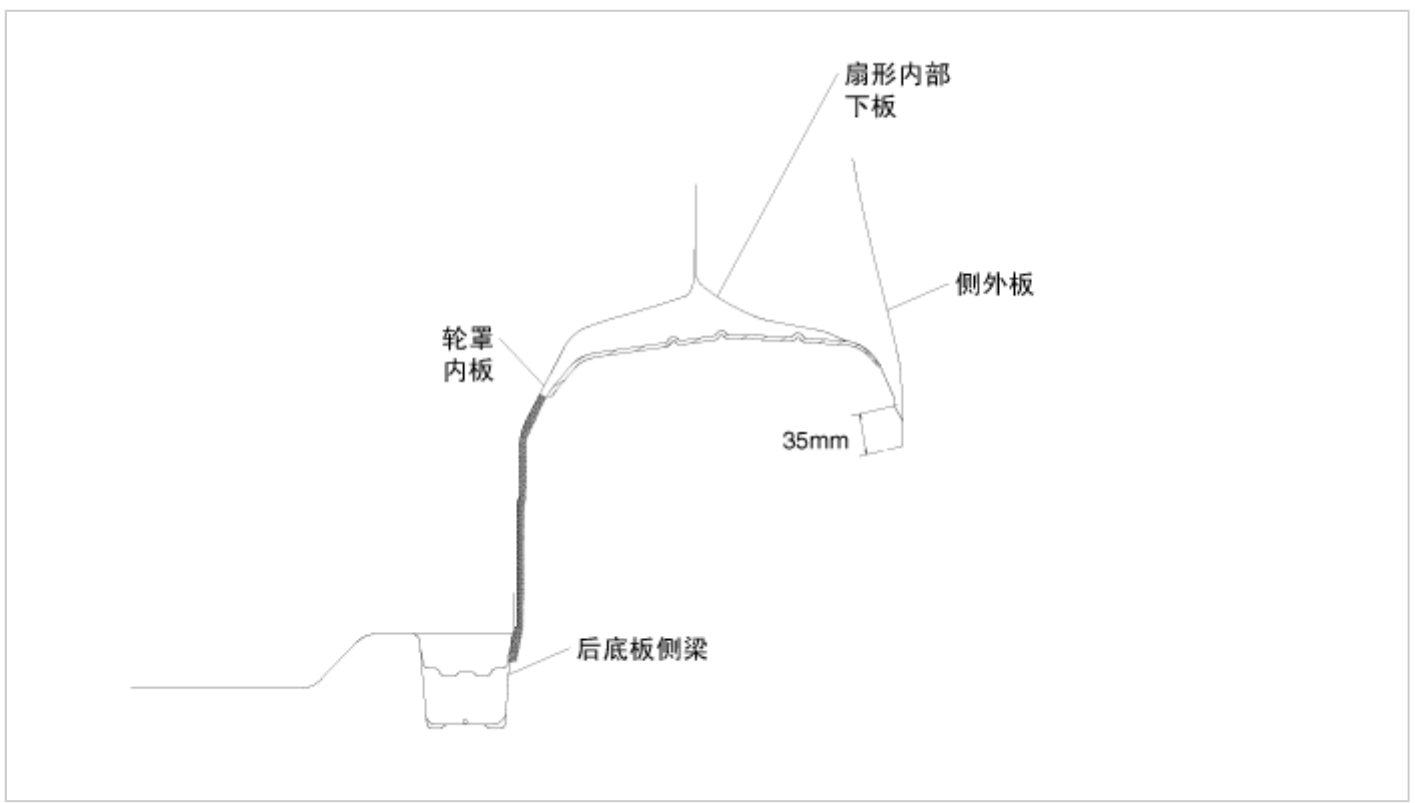

X

X'

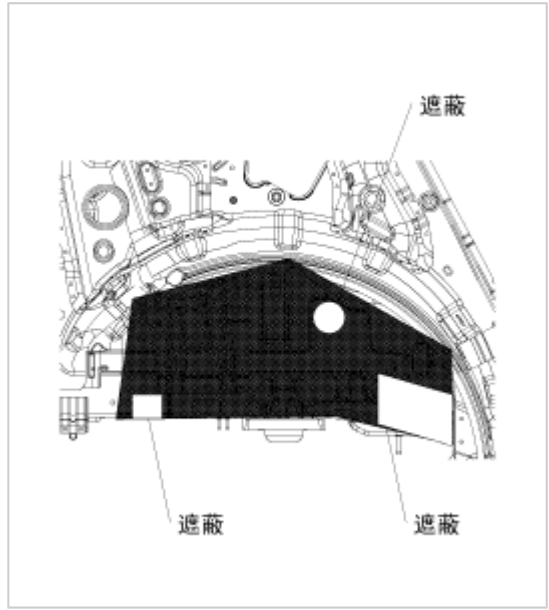
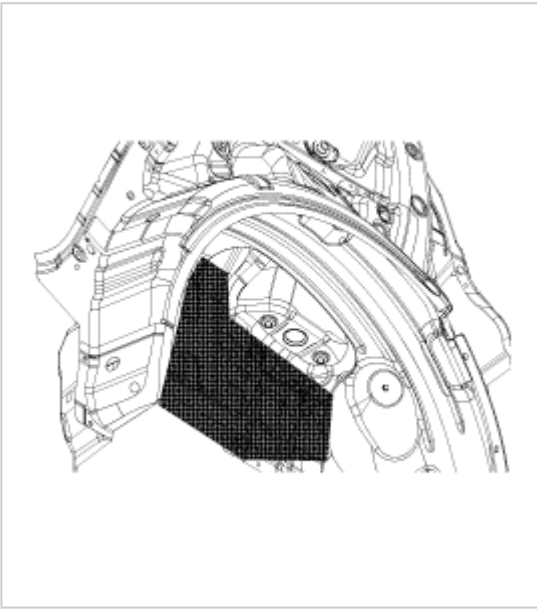

Y

